

AV-27F702/s STANDARD CIRCUIT DIAGRAM

■ NOTE ON USING CIRCUIT DIAGRAMS

1. SAFETY

The components identified by the \triangle symbol and shading are critical for safety. For continued safety replace safety critical components only with manufactures recommended parts.

2. SPECIFIED VOLTAGE AND WAVEFORM VALUES

The voltage and waveform values have been measured under the following conditions.

- (1) Input signal : Color bar signal
- (2) Setting positions of each knob/button and variable resistor : Original setting position when shipped
- (3) Internal resistance of tester : DC 20k Ω /V
- (4) Oscilloscope sweeping time : H \Rightarrow 20 μ S/div
: V \Rightarrow 5mS/div
: Others \Rightarrow Sweeping time is specified
- (5) Voltage values : All DC voltage values

* Since the voltage values of signal circuit vary to some extent according to adjustments, use them as reference values.

3. INDICATION OF PARTS SYMBOL [EXAMPLE]

- In the PW board : R1209 \rightarrow R209

4. INDICATIONS ON THE CIRCUIT DIAGRAM

(1) Resistors

- Resistance value

No unit : [Ω]
k : [k Ω]
M : [M Ω]

- Rated allowable power

No indication : 1/10 [W]
Others : As specified

- Type

No indication : Carbon resistor
OMR : Oxide metal film resistor
MFR : Metal film resistor
MPR : Metal plate resistor
UNFR : Uninflammable resistor
FR : Fusible resistor

* Composition resistor 1/2 [W] is specified as 1/2S or Comp.

(2) Capacitors

- Capacitance value

1 or higher : [pF]
less than 1 : [μ F]

- Withstand voltage

No indication : DC50[V]
AC indicated : AC withstand voltage [V]
Others : DC withstand voltage [V]

- Electrolytic Capacitors

47/50[Example] : Capacitance value [μ F]/withstand voltage[V]





- Type

No indication : Ceramic capacitor
MY : Mylar capacitor
MM : Metalized mylar capacitor
PP : Polypropylene capacitor
MPP : Metalized polypropylene capacitor
MF : Metalized film capacitor
TF : Thin film capacitor
BP : Bipolar electrolytic capacitor
TAN : Tantalum capacitor

(3) Coils

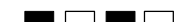

No unit : [μ H]
Others : As specified

(4) Power Supply



 : B1
 : B2(12V)
 : 9V
 : 5V

* Respective voltage values are indicated

(5) Test point

 : Test point
 : Only test point display

(6) Connecting method

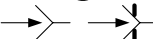
 : Connector
 : Wrapping or soldering
 : Receptacle

(7) Ground symbol

\perp : LIVE side ground
 \nmid : ISOLATED(NEUTRAL) side ground
 \equiv : EARTH ground
 ∇ : DIGITAL ground

5. NOTE FOR REPAIRING SERVICE

This model's power circuit is partly different in the GND. The difference of the GND is shown by the LIVE : (\perp) side GND and the ISOLATED(NEUTRAL) : (\nmid) side GND. Therefore, care must be taken for the following points.

- Do not touch the LIVE side GND or the LIVE side GND and the ISOLATED(NEUTRAL) side GND simultaneously. If the above caution is not respected, an electric shock may be caused. Therefore, make sure that the power cord is surely removed from the receptacle when, for example, the chassis is pulled out.
- Do not short between the LIVE side GND and ISOLATED(NEUTRAL) side GND or never measure with a measuring apparatus (oscilloscope, etc.) the LIVE side GND and ISOLATED(NEUTRAL) side GND at the same time. If the above precaution is not respected, a fuse or any parts will be broken.

- Since the circuit diagram is a standard one, the circuit and circuit constants may be subject to change for improvement without any notice.

CONTENTS

SEMICONDUCTOR SHAPES 2-2

BLOCK DIAGRAM 2-3

CIRCUIT DIAGRAMS 2-5

MAIN PWB CIRCUIT DIAGRAM 2-5

MAIN, FRONT, POWER SW PWB CIRCUIT DIAGRAMS 2-9

AV SW PWB CIRCUIT DIAGRAM 2-11

CRT SOCKET PWB CIRCUIT DIAGRAM 2-13

DAF PWB CIRCUIT DIAGRAM 2-15

LF PWB CIRCUIT DIAGRAM 2-17



PATTERN DIAGRAMS 2-19

MAIN PWB PATTERN 2-19

AV SW, CRT SOCKET, DAF, FRONT, POWER SW, LF PWB PATTERN 2-21

SEMICONDUCTOR SHAPES

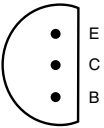
TRANSISTOR

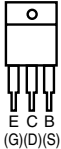
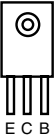
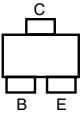
BOTTOM VIEW	FRONT VIEW			TOP VIEW
				CHIP TR 

IC

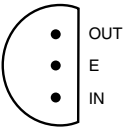
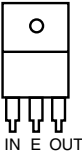
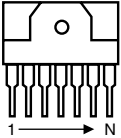
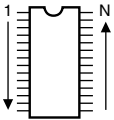
BOTTOM VIEW	FRONT VIEW		TOP VIEW
			

CHIP IC

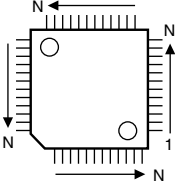
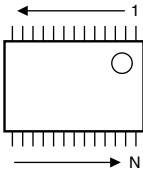
TOP VIEW	
	

BLOCK DIAGRAM

AV-27F702/s BLOCK DIAGRAM

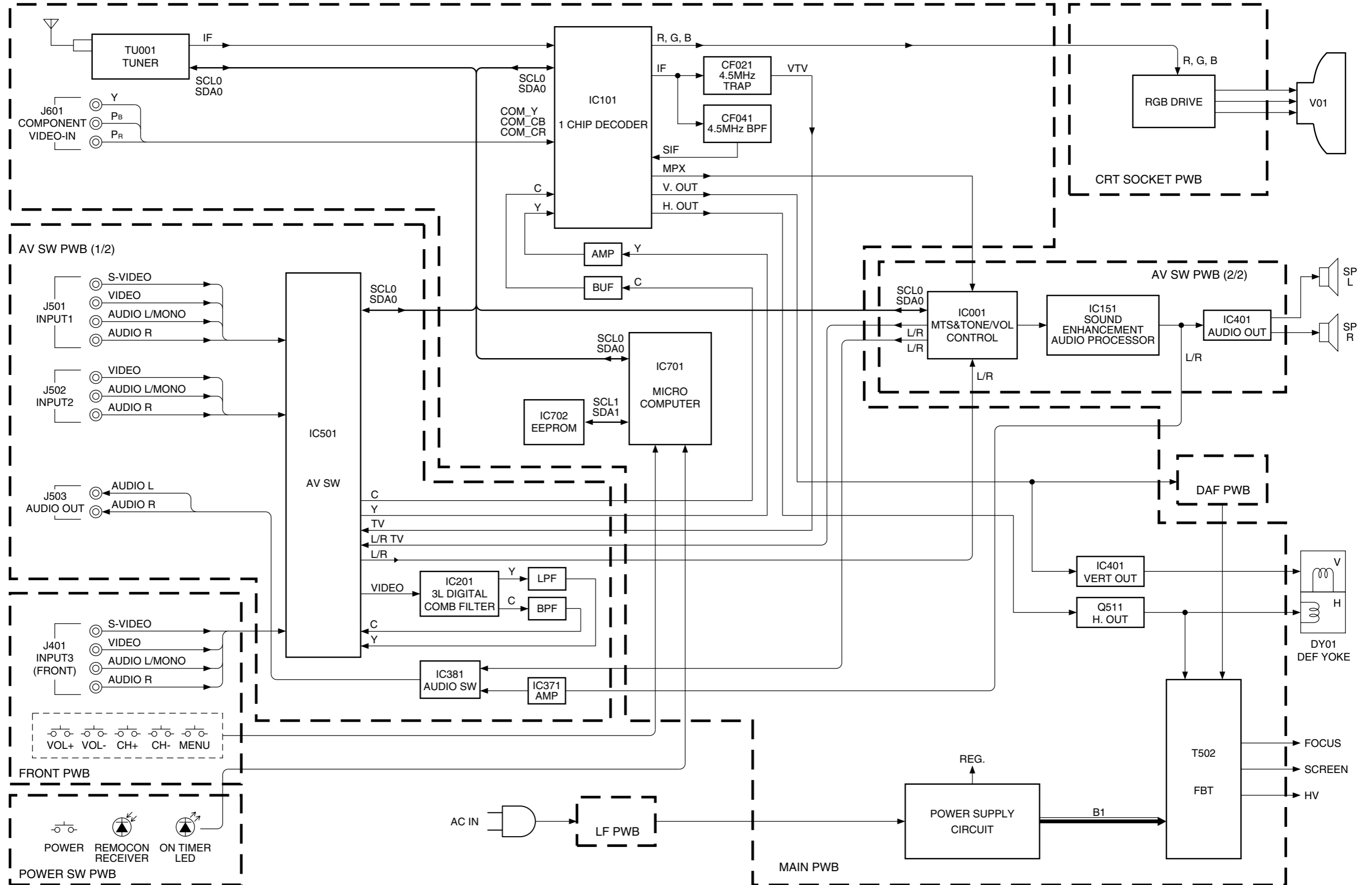

CIRCUIT DIAGRAMS

MAIN PWB CIRCUIT DIAGRAM

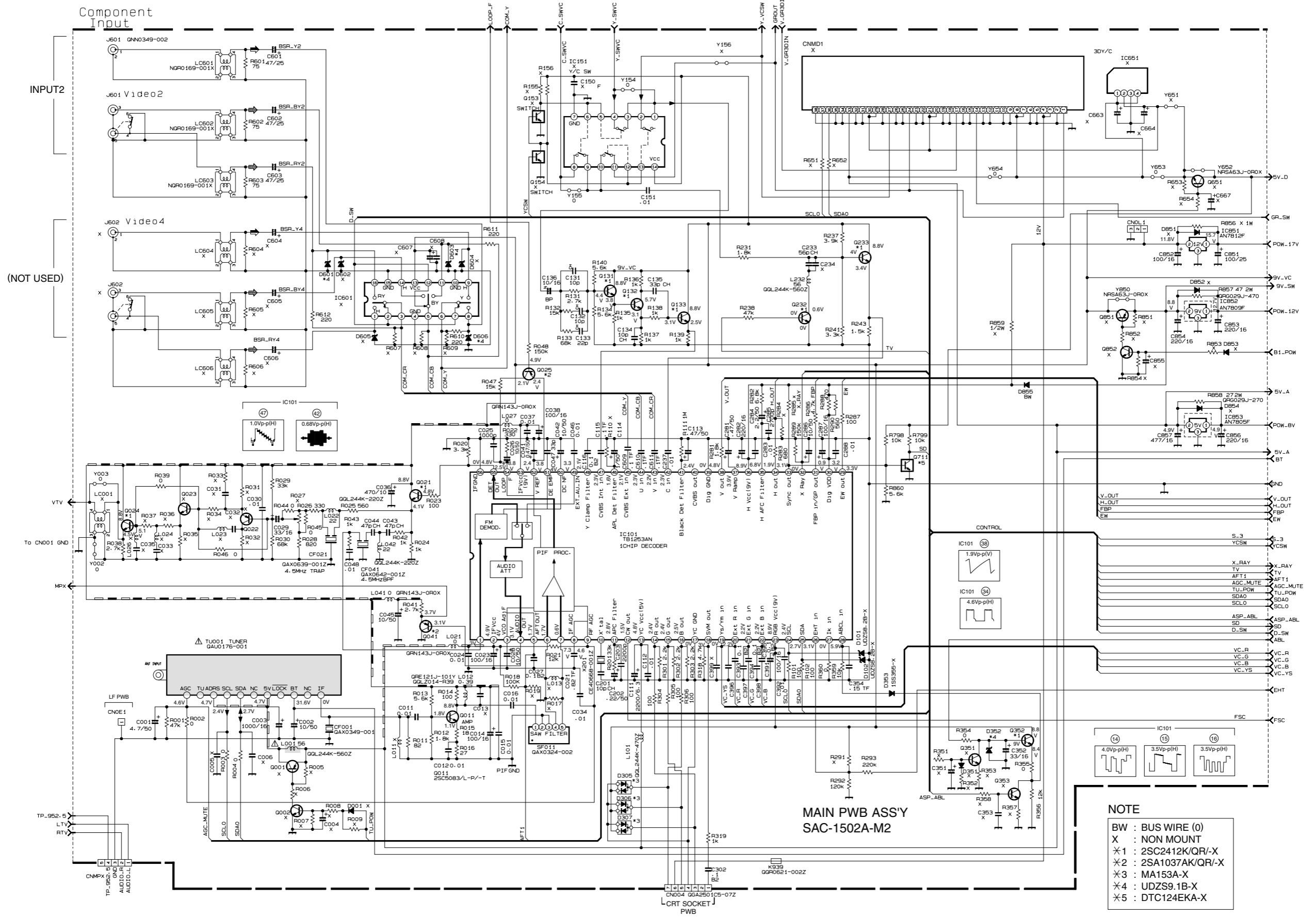

NOTE

- BW : BUS WIRE (0)
- X : NON MOUNT
- *1 : 2SC2412K/QR-X
- *2 : 2SA1037AK/QR-X
- *3 : MA153A-X
- *4 : UDZS9.1B-X
- *5 : DTC124EKA-X

MAIN PWB CIRCUIT DIAGRAM

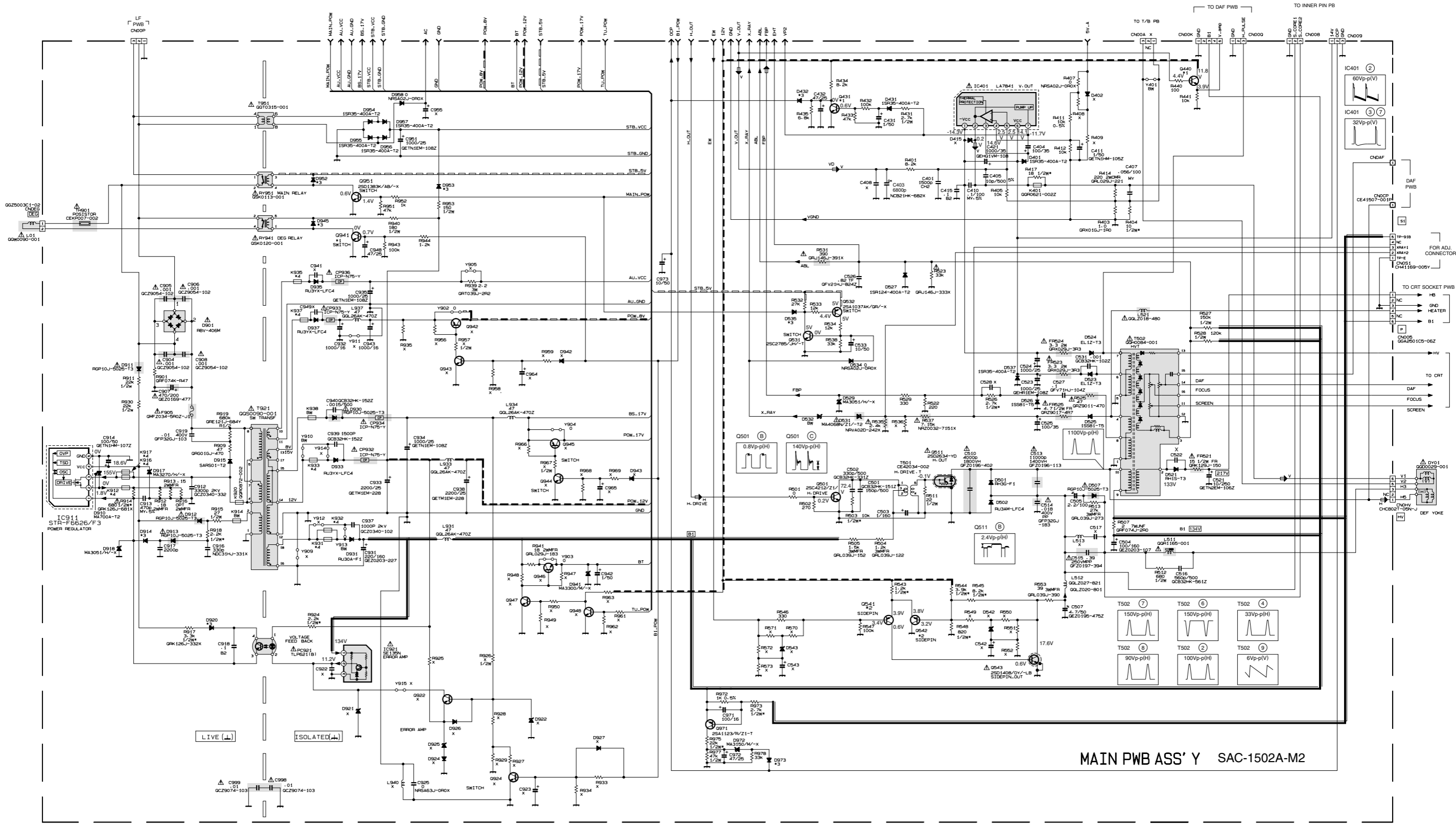

MAIN PWB ASS' Y SAC-1502A-M2

NOTE

- BW : BUS WIRE (0)
- X : NON MOUNT
- *1 : 2SC2412K/QR/-X
- *2 : 2SA1037AK/QR/-X
- *3 : 1SS355-X
- *4 : QQR0582-001Z

MAIN, FRONT, POWER SW PWB CIRCUIT DIAGRAMS

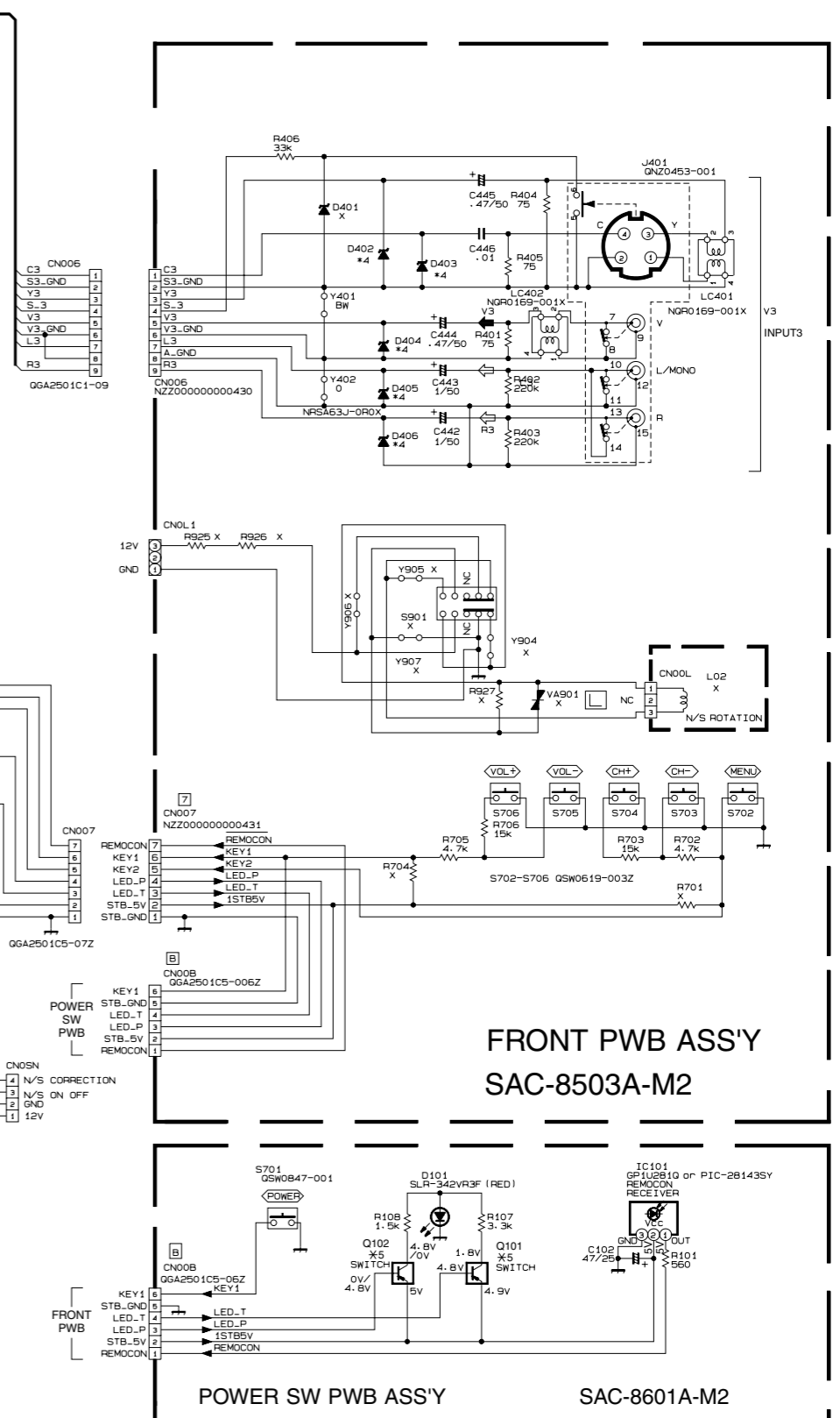
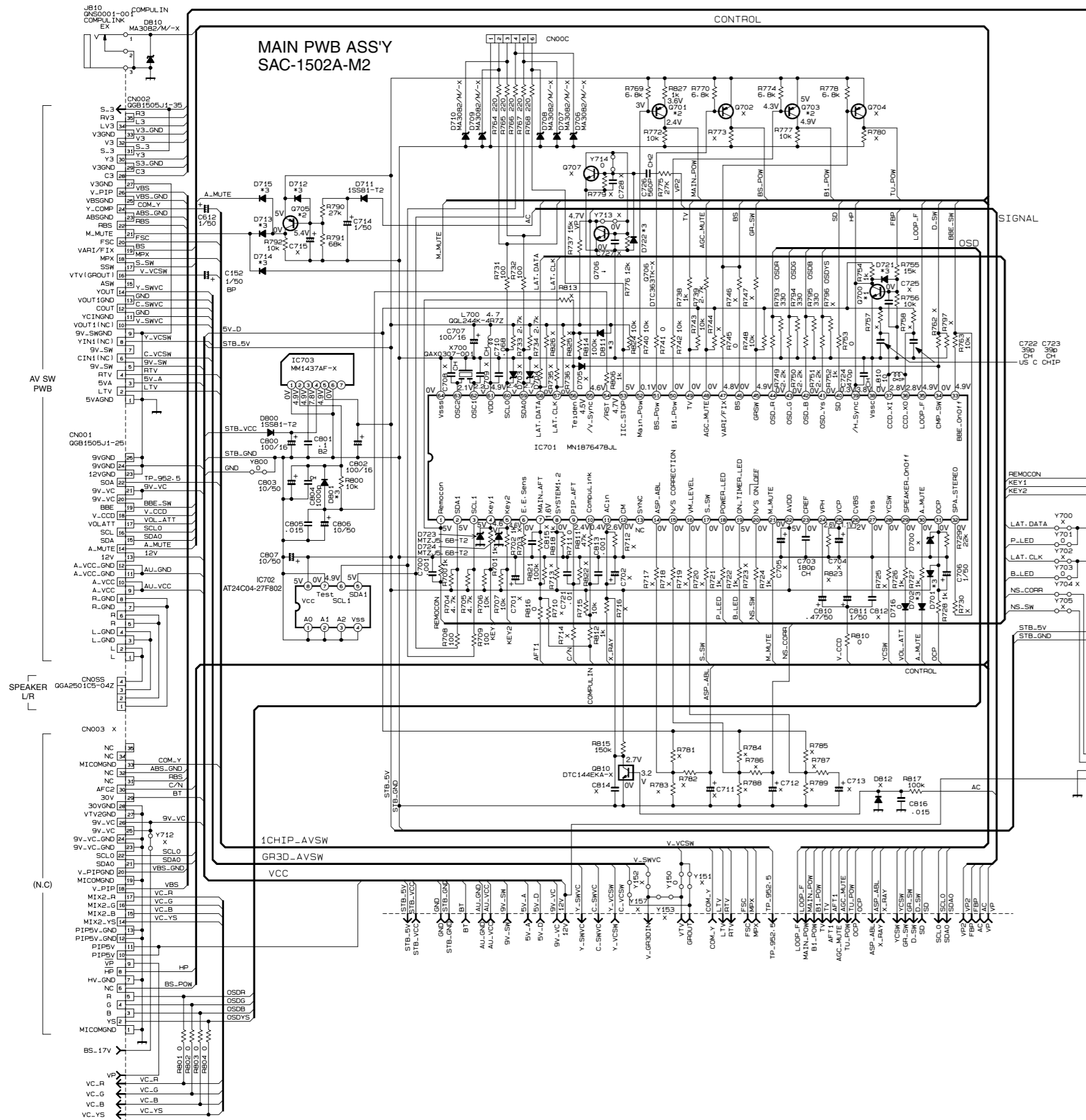

NOTE

- BW : BUS WIRE (0)
- X : NON MOUNT
- *1 : 2SC2412K/AK/QR-X
- *2 : 2SA1037AK/QR-X
- *3 : 1SS355-X
- *4 : UDZS10B-X
- *5 : DTA124KA-X

AV SW PWB CIRCUIT DIAGRAM

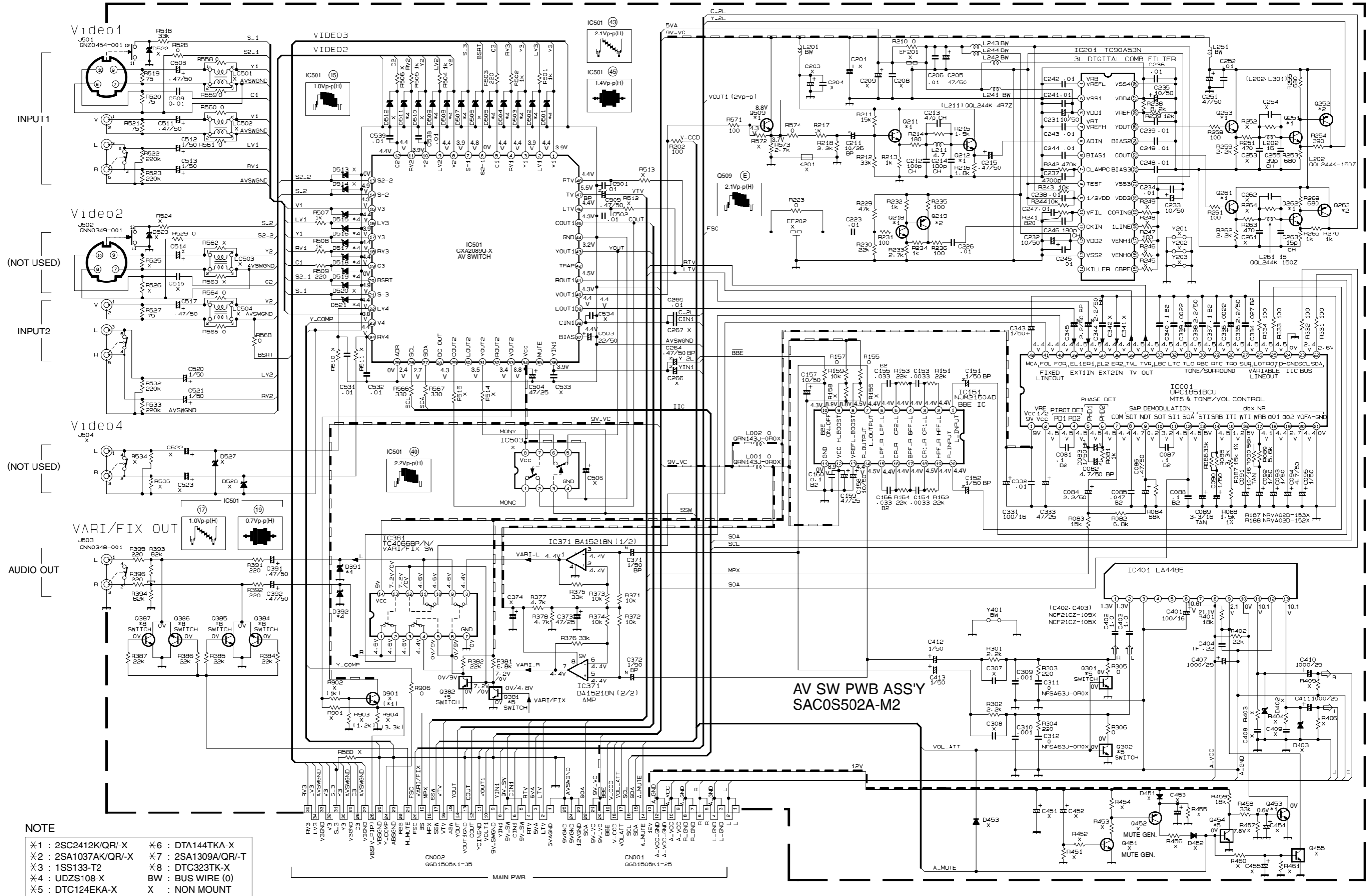

NOTE

*1 : 2SC2412K/QR-X	*6 : DTA144TKA-X
*2 : 2SA1037AK/QR-X	*7 : 2SA1309A/QR-T
*3 : 1SS133-T2	*8 : DTC323TK-X
*4 : UDZS108-X	BW : BUS WIRE (0)
*5 : DTC124EKA-X	X : NON MOUNT

CRT SOCKET PWB CIRCUIT DIAGRAM

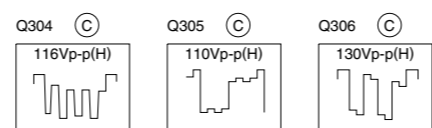
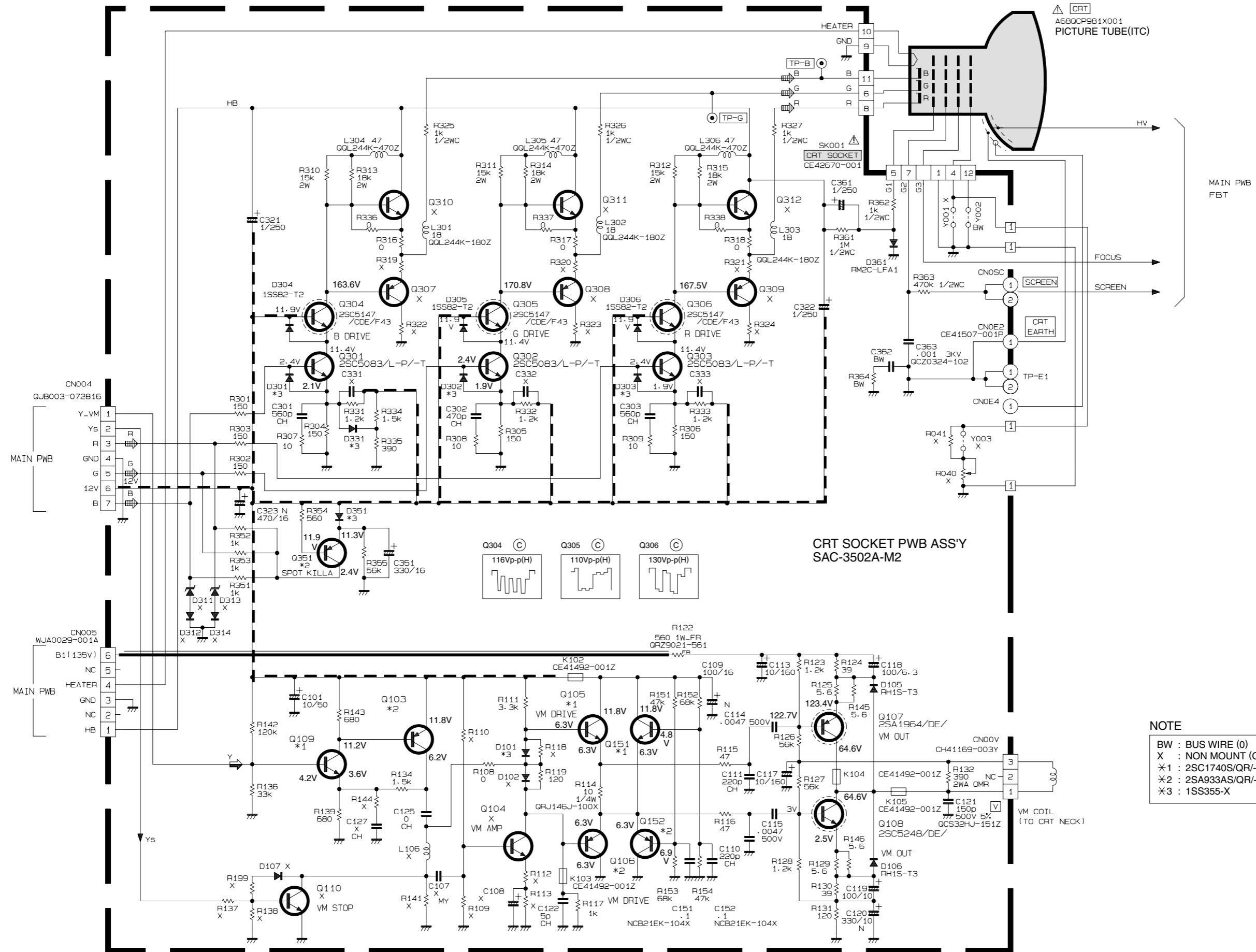

CRT SOCKET PWB ASS'Y SAC-3502A-M2

NOTE

- BW : BUS WIRE (0)
- X : NON MOUNT (OPEN)
- *1 : 2SC1740S/QR/-T
- *2 : 2SA933AS/QR/-T
- *3 : 1SS355-X

DAF PWB CIRCUIT DIAGRAM

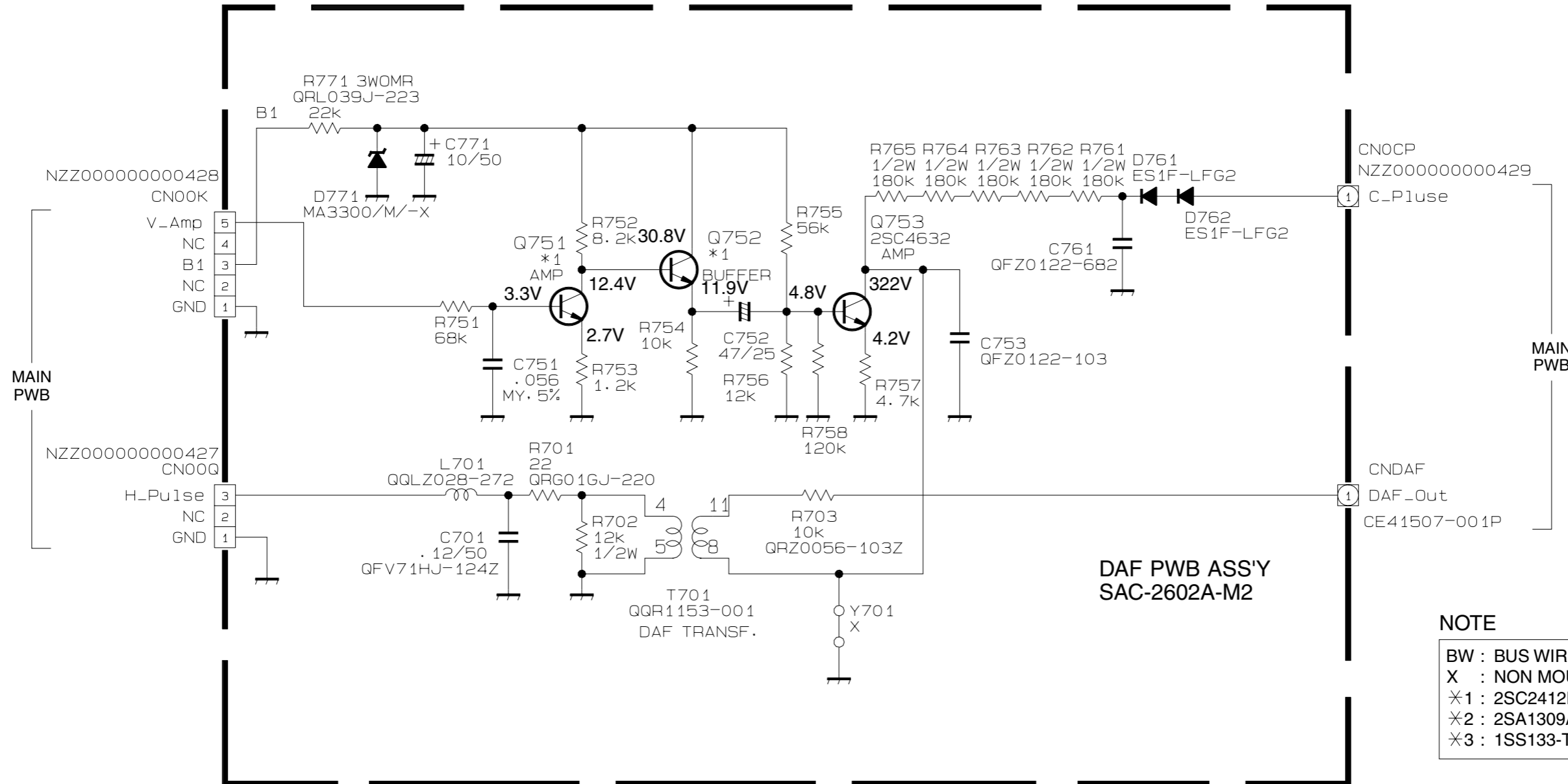

LF PWB CIRCUIT DIAGRAM

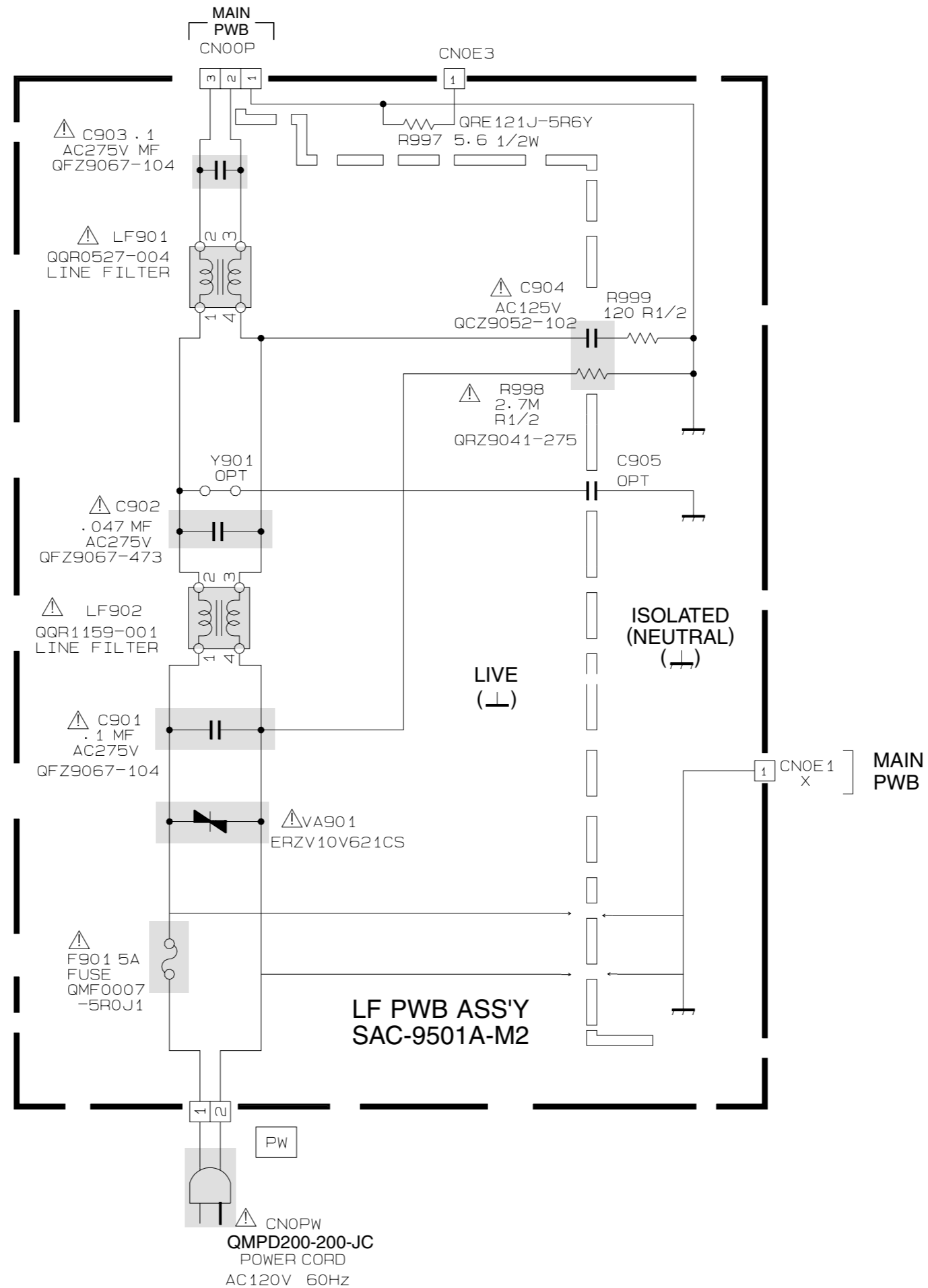

PATTERN DIAGRAMS
[MAIN PWB PATTERN]

TP-91B(B1) (TP-E)



CAUTION: FOR CONTINUED PROTECTION AGAINST FIRE HAZARD, REPLACE ONLY WITH SAME TYPE AND RATED FUSE(S) AND ROHM'S MFR'S TYPE CP(S).

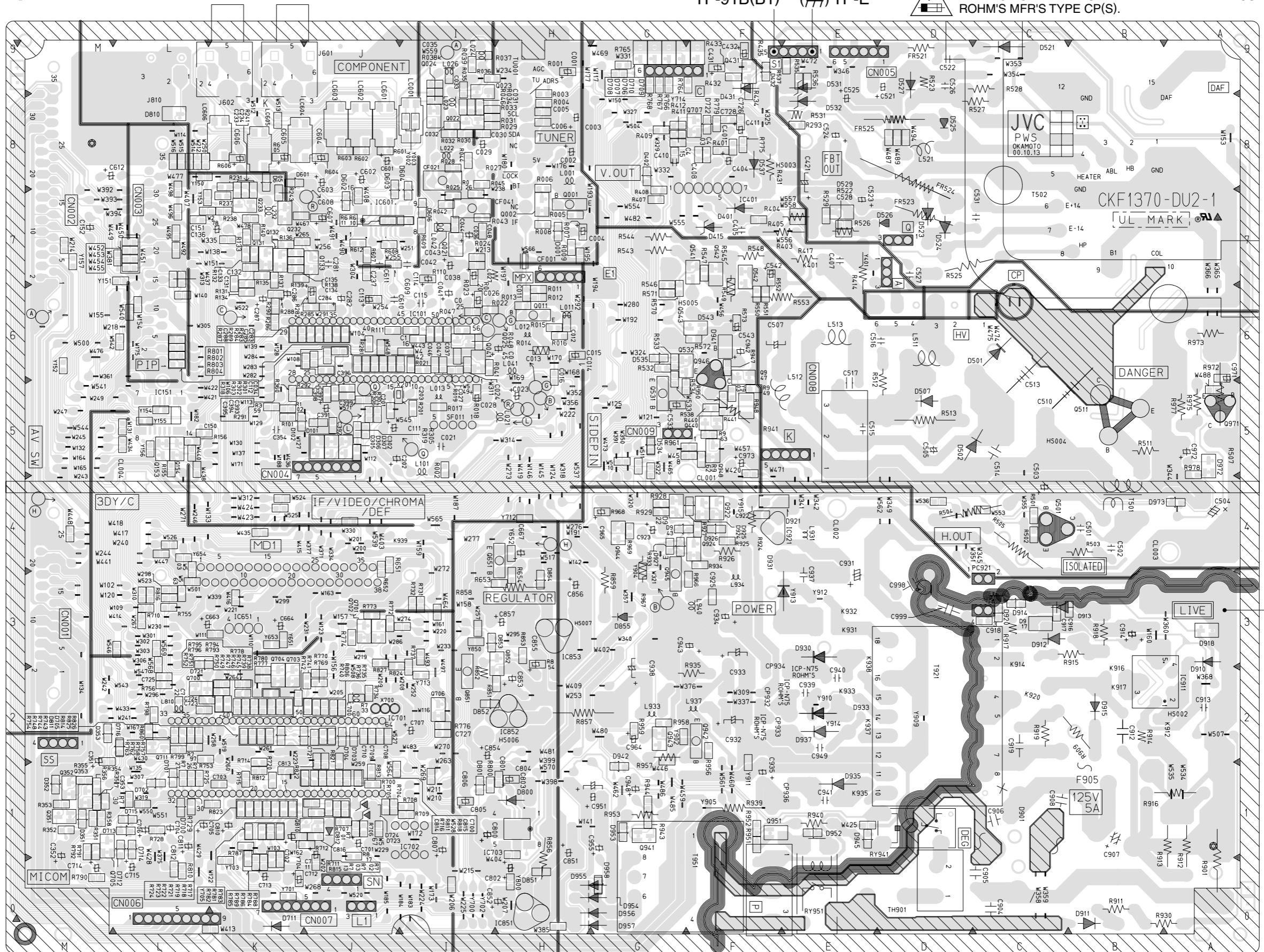
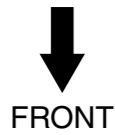

[AV SW, CRT SOCKET, DAF, FRONT, POWER SW, LF PWB PATTERN]

FRONT

TOP

TOP

FRONT

DAF PWB

FRONT

FRONT PWB

FRONT

FRONT

POWER SW PWB

No.51786

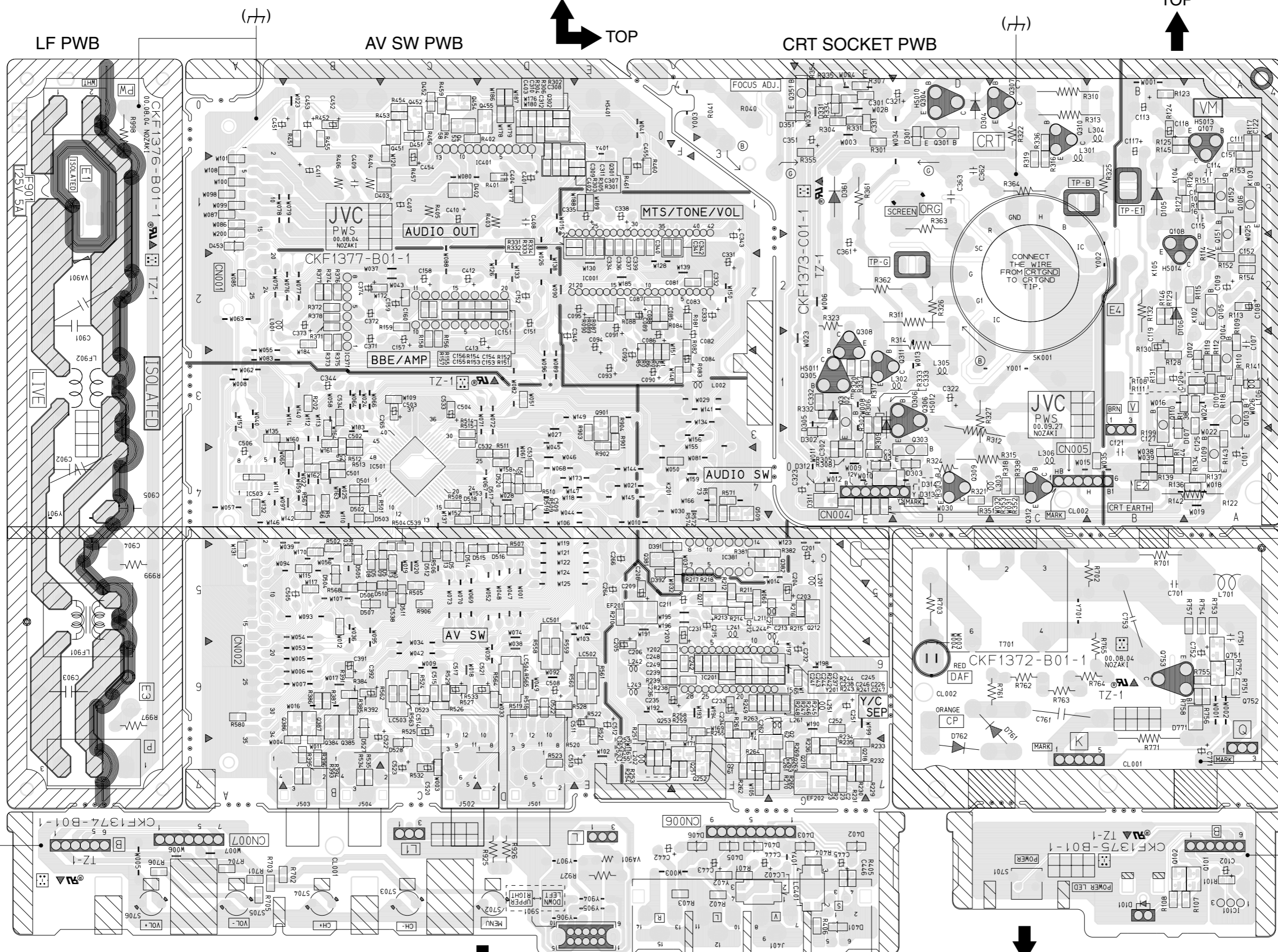

No.51786

2-21

2-22

No.51786